

1. General Features

- n Proprietary New Planar Technology
- n $R_{DS(ON),typ.}=0.35\Omega@V_{GS}=10V$
- n Low Gate Charge Minimize Switching Loss
- n Fast Recovery Body Diode

2. Applications

- n Ballast and Lighting
- n DC-AC Inverter
- n Other Applications

3. Pin configuration

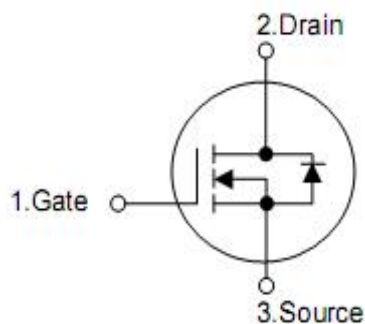
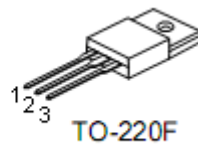
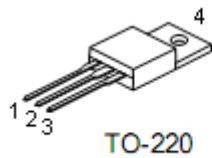

Pin	Function
1	Gate
2	Drain
3	Source
4	Drain

4. Ordering Information

Part Number	Package	Brand
KNP6140A	TO-220	KIA
KNF6140A	TO-220F	KIA

5. Absolute maximum ratings

(T_c= 25 °C , unless otherwise specified)

Symbol	Parameter	KNP6140A	KNF6140A	Unit
V _{DSS}	Drain-to-Source Voltage ^[1]	400		V
V _{GSS}	Gate-to-Source Voltage	±30		
I _D	Continuous Drain Current	10	10*	A
	Continuous Drain Current@ T _c =100 °C	Figure3		
I _{DM}	Pulsed Drain Current at V _{GS} =10V ^[2]	Figure6		
E _{AS}	Single Pulse Avalanche Energy	650		mJ
dv /dt	Peak Diode Recovery dv/dt ^[3]	5.0		V/ns
P _D	Power Dissipation	140	45	W
	Derating Factor above 25 °C	1.12	0.37	W/ °C
T _L T _{PAK}	Maximum Temperature for Soldering Leads at 0.063in (1.6mm) from Case for 10 seconds, Package Body for 10 seconds	300 260		°C
T _J &T _{STG}	Operating and Storage Temperature Range	-55 to 150		

*Drain current limited by maximum junction temperature

Caution: Stresses greater than those listed in the “Absolute Maximum Ratings” may cause permanent damage to the device.

6. Thermal characteristics

Symbol	Parameter	KNP6140A	KNF6140A	Unit
R _{θJC}	Thermal Resistance, Junction-to-Case	0.89	2.7	°C /W
R _{θJA}	Thermal Resistance, Junction-to-Ambient	62	100	

7. Electrical characteristics

OFF Characteristics		(T _J =25°C, unless otherwise specified)				
Symbol	Parameter	Test Conditions	Min.	Typ.	Max.	Unit
B _V DSS	Drain-to-Source Breakdown Voltage	V _{GS} =0V, I _D =250uA	400	--	--	V
I _{DSS}	Drain-to-Source Leakage Current	V _{DS} =400V, V _{GS} =0V	--	--	1	uA
		V _{DS} =320V, V _{GS} =0V, T _J =125°C	--	--	100	
I _{GSS}	Gate-to-Source Leakage Current	V _{GS} =+30V, V _{DS} =0V	--	--	+100	nA
		V _{GS} =-30V, V _{DS} =0V	--	--	-100	
ON Characteristics		(T _J =25°C, unless otherwise specified)				
Symbol	Parameter	Test Conditions	Min.	Typ.	Max.	Unit
R _{DS(ON)}	Static Drain-to-Source On-Resistance ^[4]	V _{GS} =10V, I _D =5A	--	0.35	0.5	Ω
V _{GS(TH)}	Gate Threshold Voltage	V _{DS} =V _{GS} , I _D =250uA	2.0	--	4.0	V
g _{FS}	Forward Transconductance ^[4]	V _{DS} =20V, I _D =10A	--	12	--	S
Dynamic Characteristics		Essentially independent of operating temperature				
Symbol	Parameter	Test Conditions	Min.	Typ.	Max.	Unit
C _{iss}	Input Capacitance	V _{GS} =0V, V _{DS} =25V, f=1.0MHZ	--	1254	--	pF
C _{rss}	Reverse Transfer Capacitance		--	21	--	
C _{oss}	Output Capacitance		--	150	--	
Q _g	Total Gate Charge	V _{DD} =200V, I _D =10A, V _{GS} =0 to 10V	--	28	--	nC
Q _{gs}	Gate-to-Source Charge		--	7.0	--	
Q _{gd}	Gate-to-Drain (Miller) Charge		--	11	--	
Resistive Switching Characteristics		Essentially independent of operating temperature				
Symbol	Parameter	Test Conditions	Min.	Typ.	Max.	Unit
t _{d(ON)}	Turn-on Delay Time	V _{DD} =200V, I _D =10A, V _{GS} = 10V, R _G =12Ω	--	14	--	nS
t _{rise}	Rise Time		--	25	--	
t _{d(OFF)}	Turn-Off Delay Time		--	44	--	
t _{fall}	Fall Time		--	28	--	
Source-Drain Body Diode Characteristics		(T _J =25°C, unless otherwise specified)				
Symbol	Parameter	Test Conditions	Min.	Typ.	Max.	Unit
I _{SD}	Continuous Source Current ^[4]	Integral PN-diode in MOSFET	--	--	10	A
I _{SM}	Pulsed Source Current ^[4]		--	--	40	
V _{SD}	Diode Forward Voltage	I _S =10A, V _{GS} =0V	--	--	1.5	V
t _{rr}	Reverse recovery time	V _{GS} =0V, I _F =10A, diF/dt=100A/μs	--	303	--	ns
Q _{rr}	Reverse recovery charge		--	1.8	--	uC

Note:

1. T_J=+25°C to +150°C
2. Repetitive rating; pulse width limited by maximum junction temperature.
3. I_{SD}=10A di/dt<100A/μs, V_{DD}<B_VDSS, T_J=+150°C.
4. Pulse width≤380μs; duty cycle≤2%.

8. Test circuits and waveforms

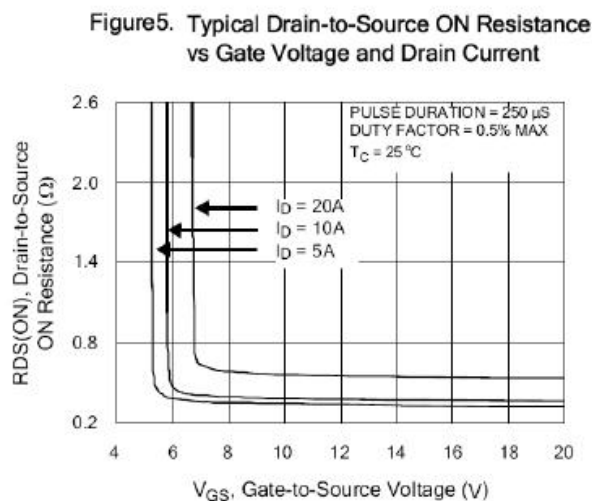
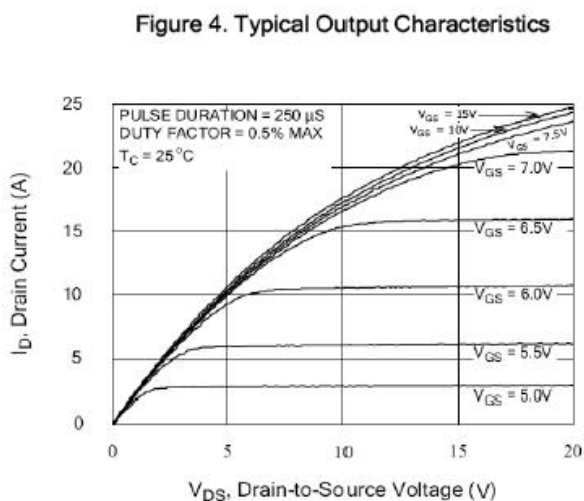
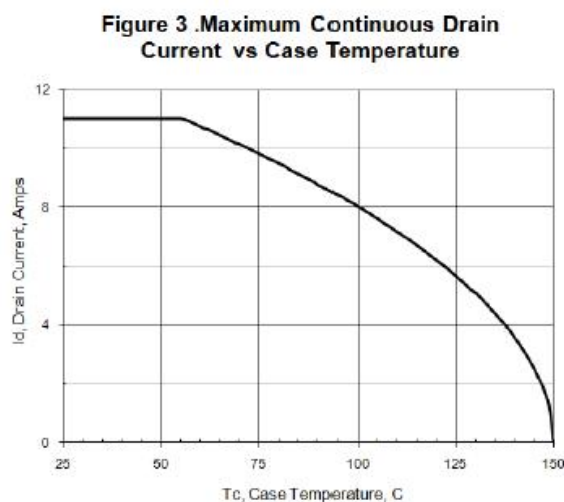
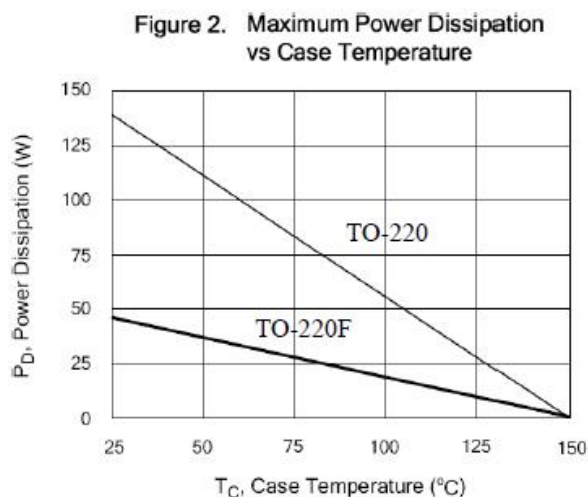
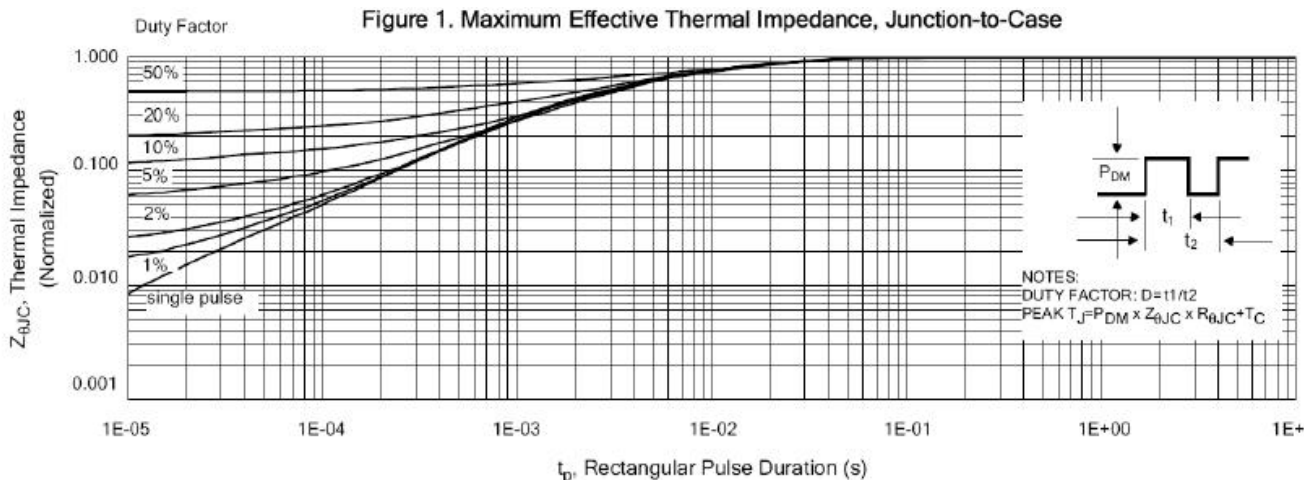

Figure 6. Peak Current Capability

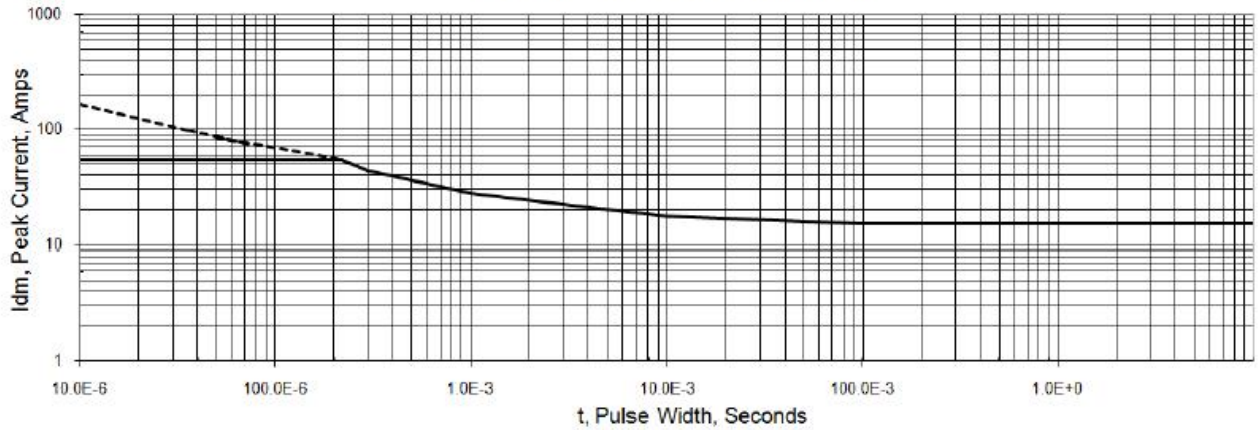

Figure 7. Typical Transfer Characteristics

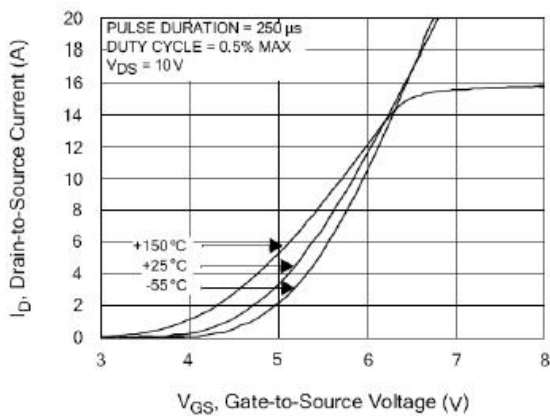

Figure 9. Typical Drain-to-Source ON Resistance vs Drain Current

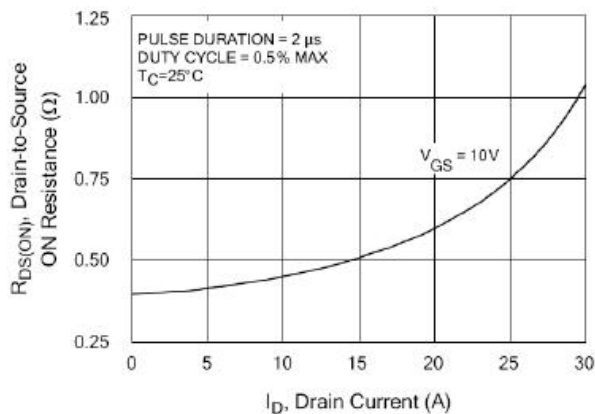

Figure 8. Unclamped Inductive Switching Capability

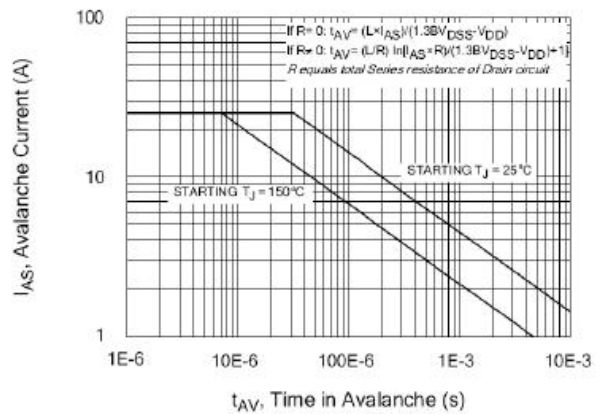

Figure 10. Typical Drain-to-Source ON Resistance vs Junction Temperature

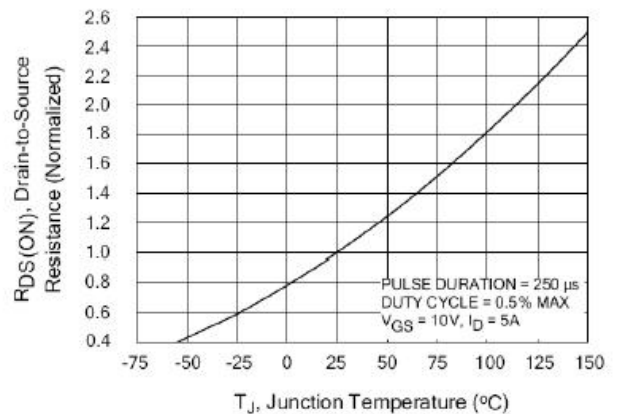

Figure 11. Typical Breakdown Voltage vs Junction Temperature

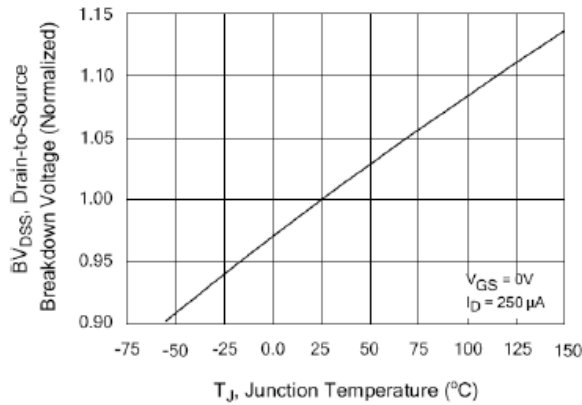

Figure 12. Typical Threshold Voltage vs Junction Temperature

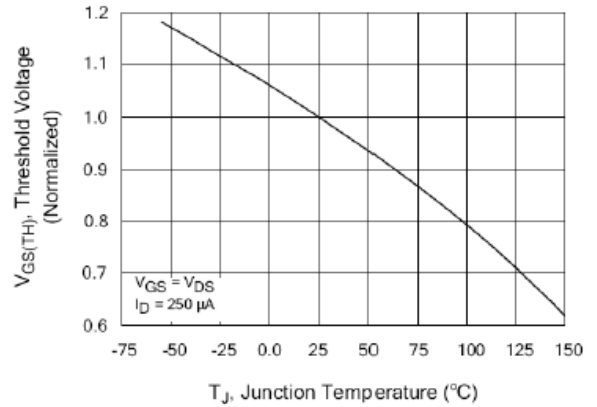

Figure 13. Maximum Forward Bias Safe Operating Area

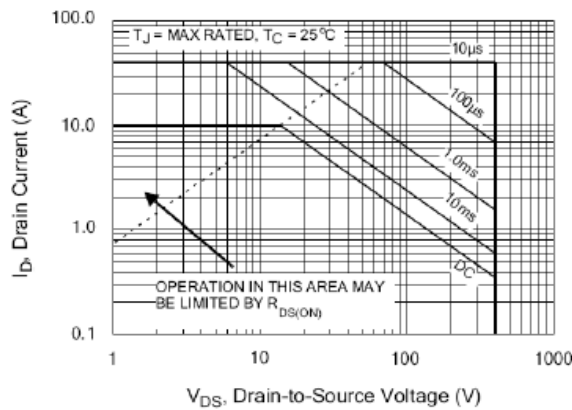

Figure 14. Typical Capacitance vs Drain-to-Source Voltage

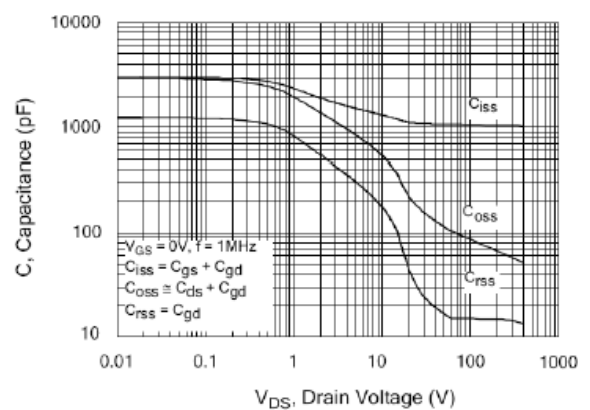

Figure 15. Typical Gate Charge vs Gate-to-Source Voltage

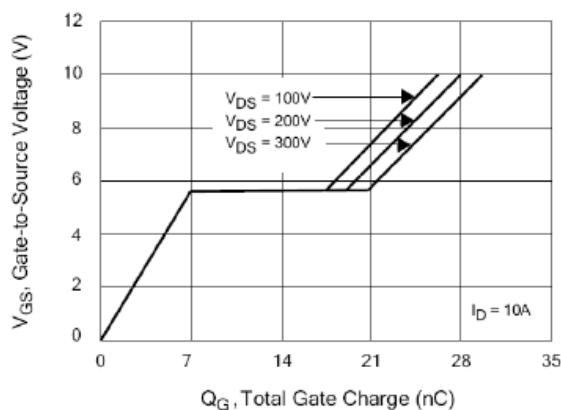
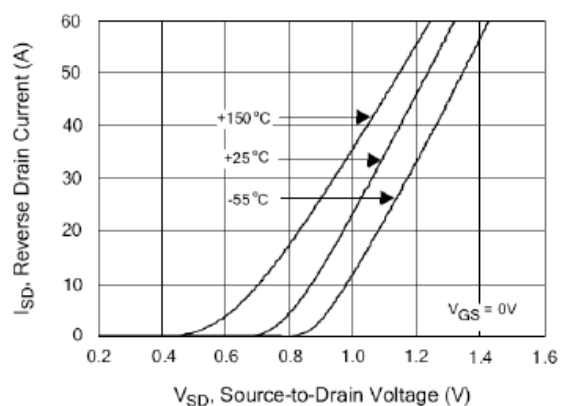

Figure 16. Typical Body Diode Transfer Characteristics



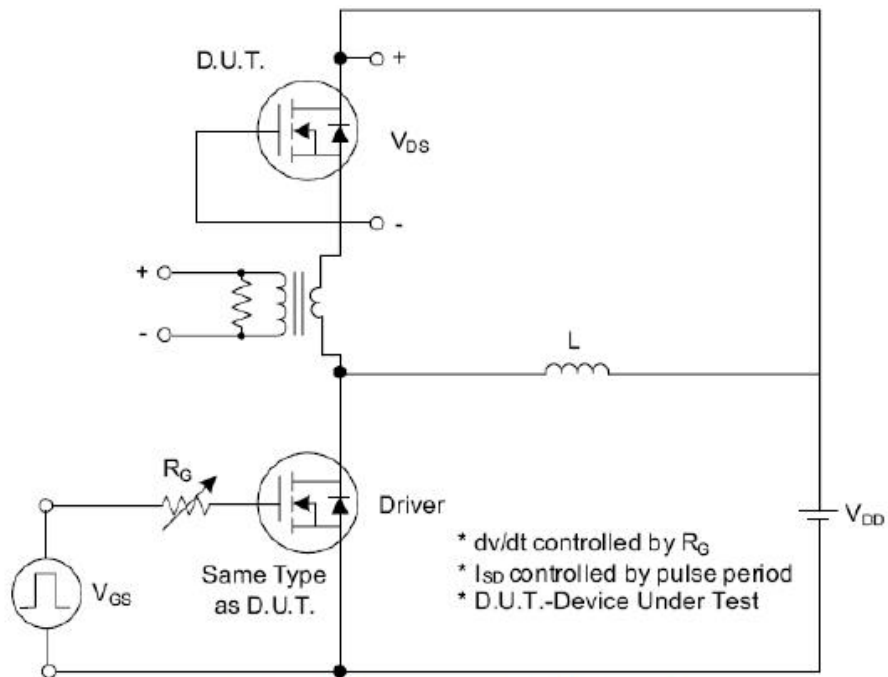

Fig. 1.1 Peak Diode Recovery dv/dt Test Circuit

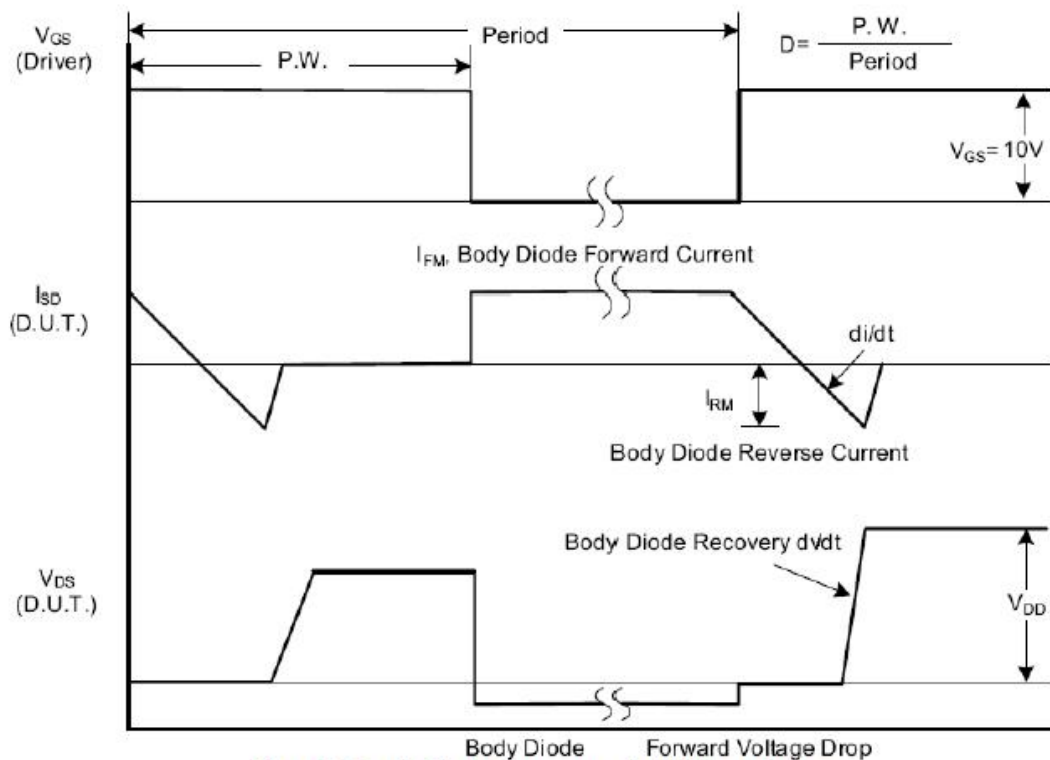

Fig. 1.2 Peak Diode Recovery dv/dt Waveforms

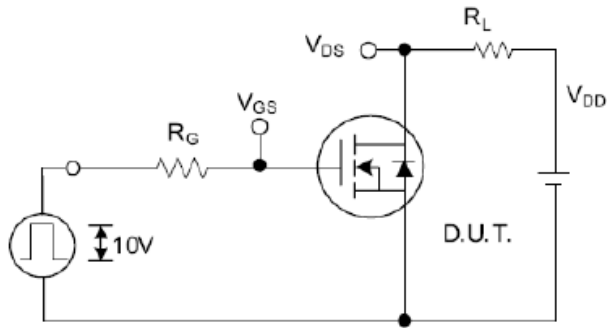

Fig. 2.1 Switching Test Circuit

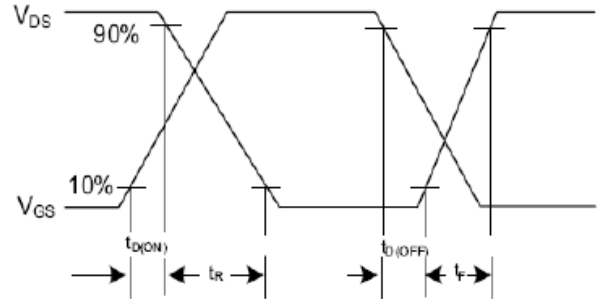

Fig. 2.2 Switching Waveforms

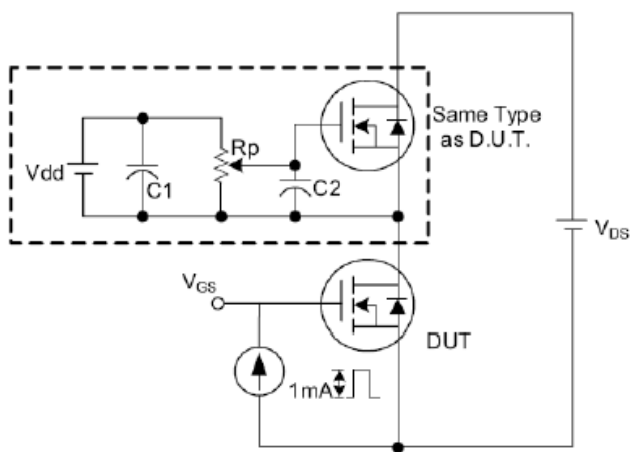

Fig. 3. 1 Gate Charge Test Circuit

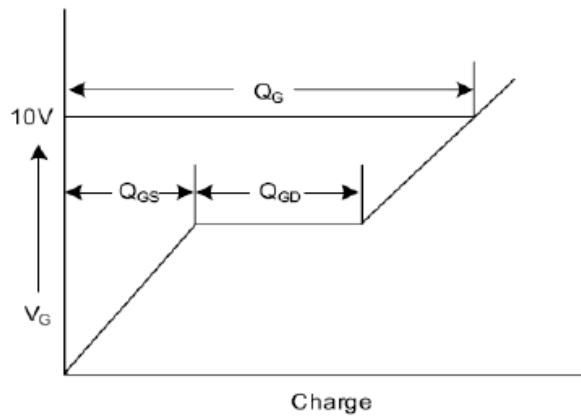

Fig. 3. 2 Gate Charge Waveform

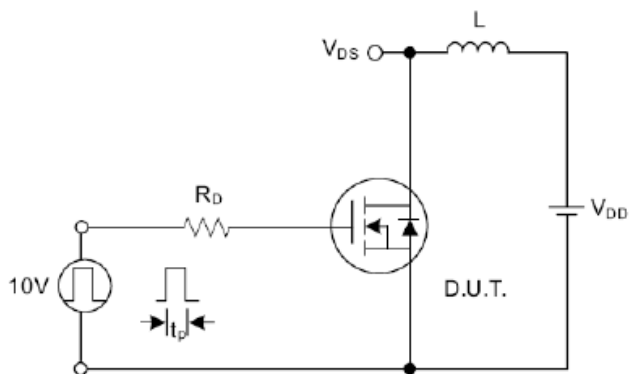

Fig. 4.1 Unclamped Inductive Switching Test Circuit

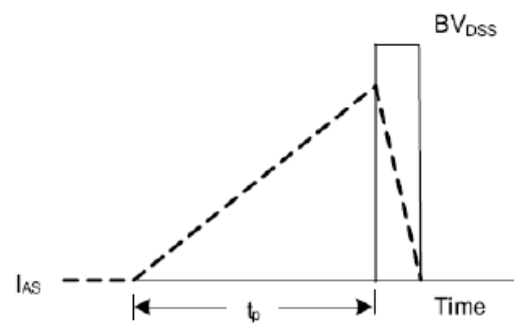

Fig. 4.2 Unclamped Inductive Switching Waveforms