

## 1. Features

- n  $R_{DS(on)}=3.5m\Omega$  (typ.) @  $V_{GS}=10V$
- n 100% avalanche tested
- n Reliable and rugged
- n Lead free and green device available (RoHS Compliant)

## 2. Applications

- n Switching application
- n Power management for inverter systems
- n UPS

## 3.Symbol

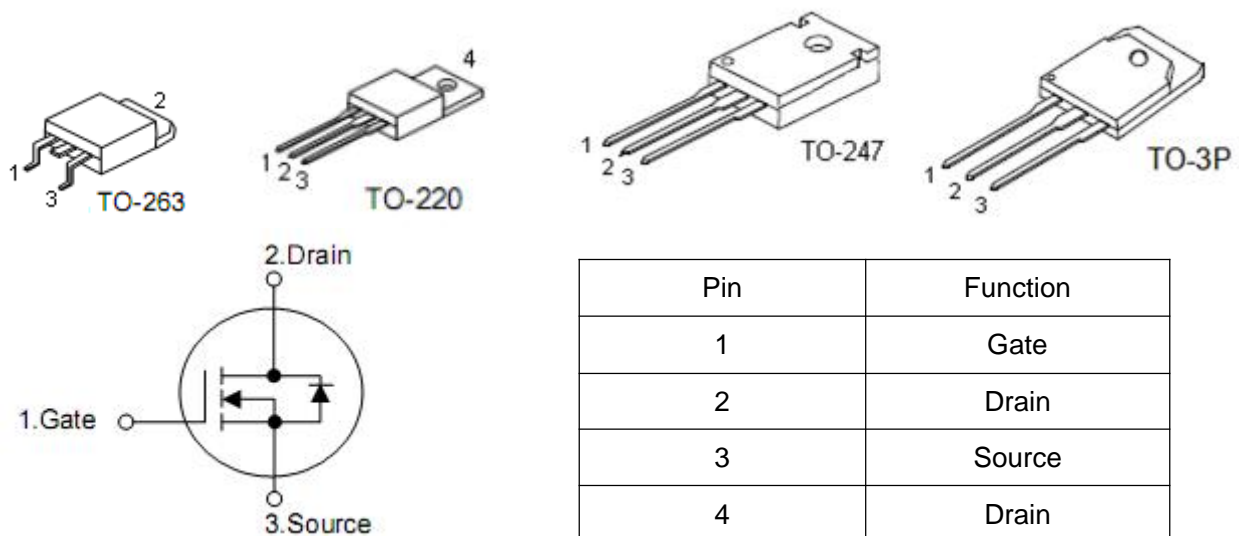

#### 4. Absolute maximum ratings

( $T_A=25^{\circ}\text{C}$ , unless otherwise noted)

Parameter	Symbol	Rating		Units
		TO-220/263	TO-247/3P	
Drain-source voltage	$V_{DSS}$	60		V
Gate-source voltage	$V_{GSS}$	$\pm 25$		V
Maximum junction temperature	$T_J$	175		$^{\circ}\text{C}$
Storage temperature range	$T_{STG}$	-55 to 175		$^{\circ}\text{C}$
Diode continuous forward current	$I_S$	150		A
Continuous drain current	$I_D^3$	150		A
		105		A
Pulse drain current*	$I_{DM}^4$	580		A
Avalanche energy, single pulsed	$E_{AS}^5$	1200		mJ
Maximum power dissipation	$P_D$	185	277	W
		92.5	138.5	

#### 5. Thermal characteristics

Parameter	Symbol	Rating	Unit
Thermal resistance, Junction-ambient	$R_{\theta JA}$	62.5	$^{\circ}\text{C}/\text{W}$
Thermal resistance, Junction-case	$R_{\theta JC}$	0.81	$^{\circ}\text{C}/\text{W}$

## 6. Electrical characteristics

 (T<sub>A</sub>=25°C, unless otherwise noted)

Parameter	Symbol	Test Conditions	Min	Typ	Max	Units
Drain-source breakdown voltage	BV <sub>DSS</sub>	V <sub>GS</sub> =0V, I <sub>DS</sub> =250μA	60	-	-	V
Zero gate voltage drain current	I <sub>DSS</sub>	V <sub>DS</sub> =48V, V <sub>GS</sub> =0V T <sub>J</sub> =85°C	-	-	1	μA
			-	-	10	
Gate threshold voltage	V <sub>GS(th)</sub>	V <sub>DS</sub> =V <sub>GS</sub> , I <sub>D</sub> =250μA	2.0	3.0	4.0	V
Gate leakage current	I <sub>GSS</sub>	V <sub>GS</sub> =±25V, V <sub>DS</sub> =0V	-	-	±100	nA
Drain-source on-state resistance	R <sub>DS(on)</sub> <sup>1</sup>	V <sub>GS</sub> =10V, I <sub>D</sub> =60A	-	3.5	4.5	mΩ
Gate resistance	R <sub>g</sub>	V <sub>DS</sub> =0V, V <sub>GS</sub> =0V, f=1MHz	-	0.7	-	Ω
Diode forward voltage	V <sub>SD</sub> <sup>1</sup>	I <sub>SD</sub> =60A, V <sub>GS</sub> =0V	-	0.8	1.2	V
Reverse recovery time <sup>2</sup>	t <sub>rr</sub>	I <sub>F</sub> =60A, V <sub>DD</sub> =50V di <sub>SD</sub> /dt=100A/μs	-	30	-	nS
Reverse recovery charge <sup>2</sup>	Q <sub>rr</sub>		-	50	-	nC
Input capacitance <sup>2</sup>	C <sub>iss</sub>	V <sub>DS</sub> =25V, V <sub>GS</sub> =0V, f=1MHz	-	4376	-	pF
Output capacitance <sup>2</sup>	C <sub>oss</sub>		-	857	-	
Reverse transfer capacitance <sup>2</sup>	C <sub>rss</sub>		-	334	-	
Turn-on delay time <sup>2</sup>	t <sub>d(on)</sub>	V <sub>DD</sub> =30V, I <sub>DS</sub> =60A, R <sub>G</sub> =25Ω, V <sub>GS</sub> =10V	-	28	-	ns
Rise time <sup>2</sup>	t <sub>r</sub>		-	18	-	
Turn-off delay time <sup>2</sup>	t <sub>d(off)</sub>		-	42	-	
Fall time <sup>2</sup>	t <sub>f</sub>		-	54	-	
Total gate charge <sup>2</sup>	Q <sub>g</sub>	V <sub>DS</sub> =48V, V <sub>GS</sub> =10V I <sub>DS</sub> =60A	-	130	-	nC
Gate-source charge <sup>2</sup>	Q <sub>gs</sub>		-	24	--	
Gate-drain charge <sup>2</sup>	Q <sub>gd</sub>		-	47	--	

Note: 1: Pulse test; pulse width ≤ 300μs duty cycle ≤ 2%.

2. Guaranteed by design, not subject to production testing.

3. Package limitation current is 75A, Calculated continuous current based on maximum allowable junction temperature.

4: Repetitive rating, pulse width limited by junction temperature.

 5: Starting T<sub>J</sub>=25°C, L=1mH.

**7. Test circuits and waveforms**

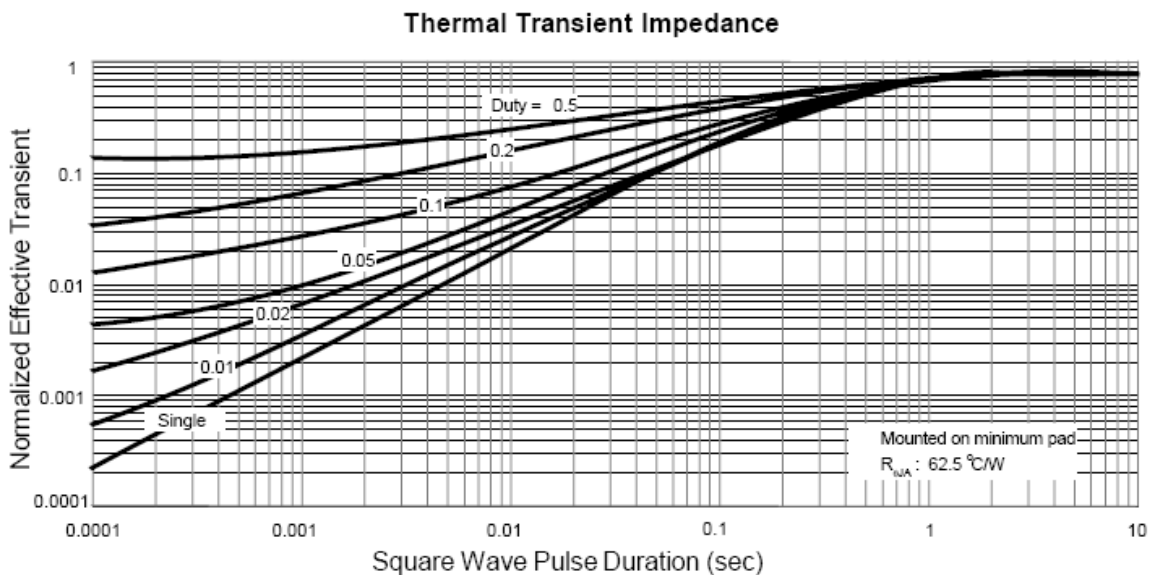
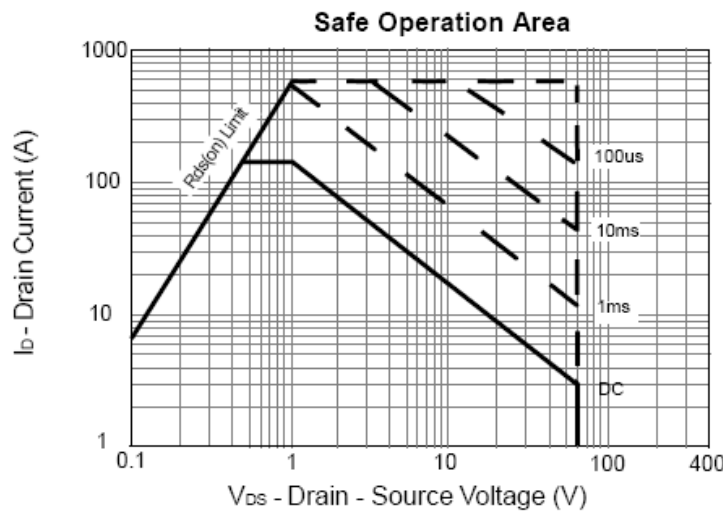
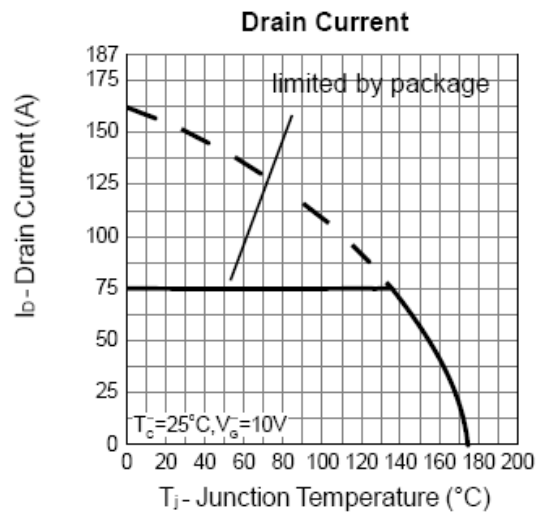
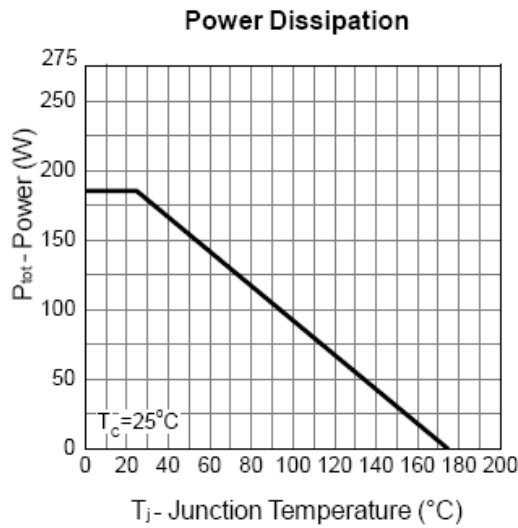

**Output Characteristics**

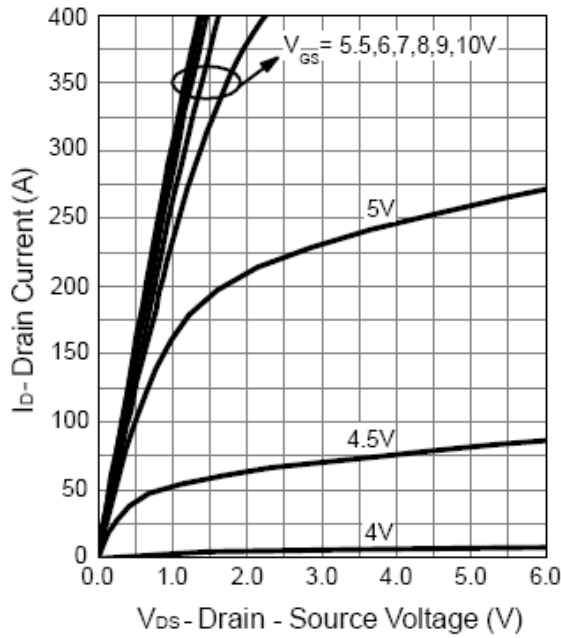

**Drain-Source On Resistance**

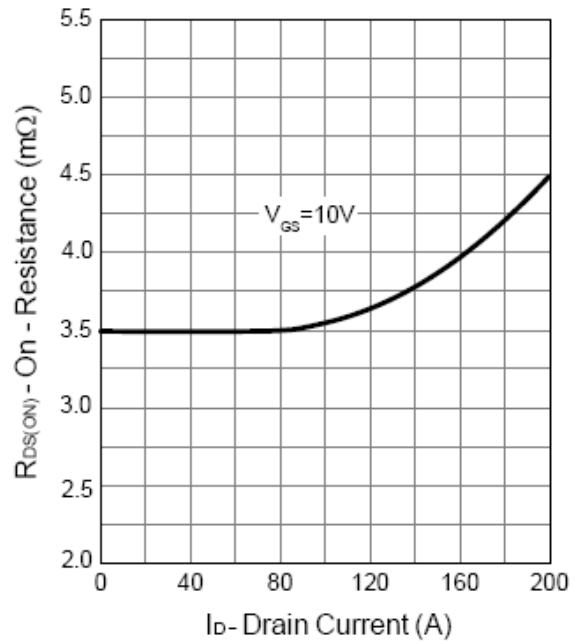

**Gate-Source On Resistance**

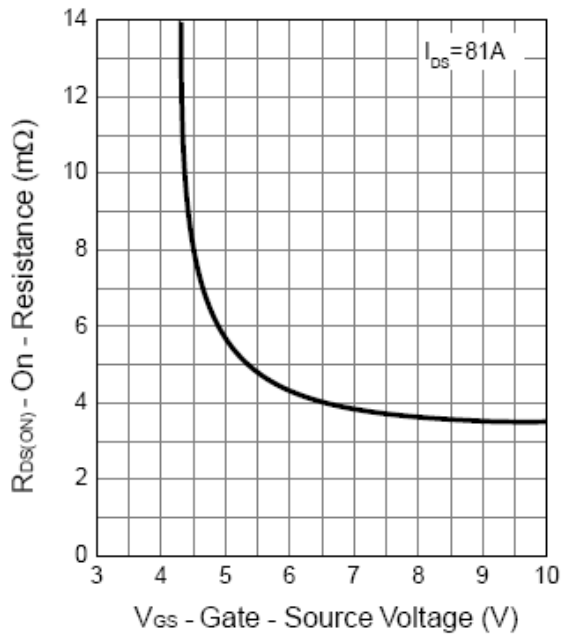

**Gate Threshold Voltage**

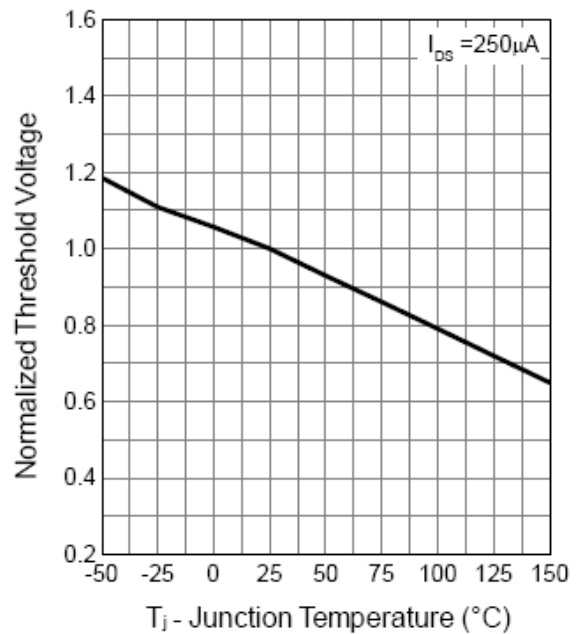

**Drain-Source On Resistance**

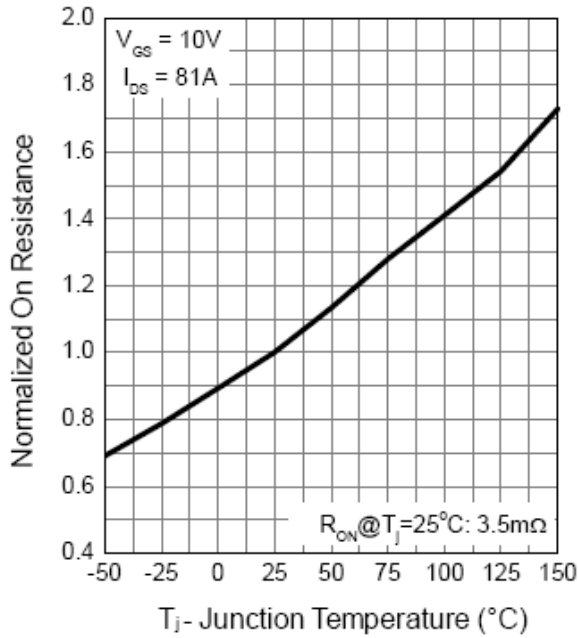

**Source-Drain Diode Forward**

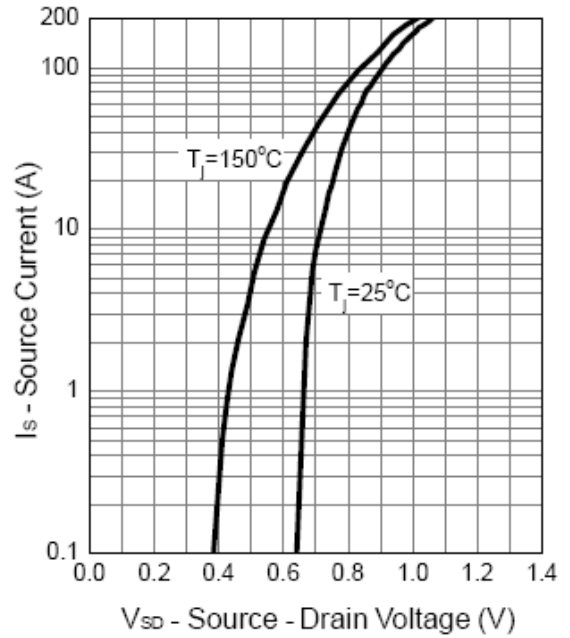

**Capacitance**

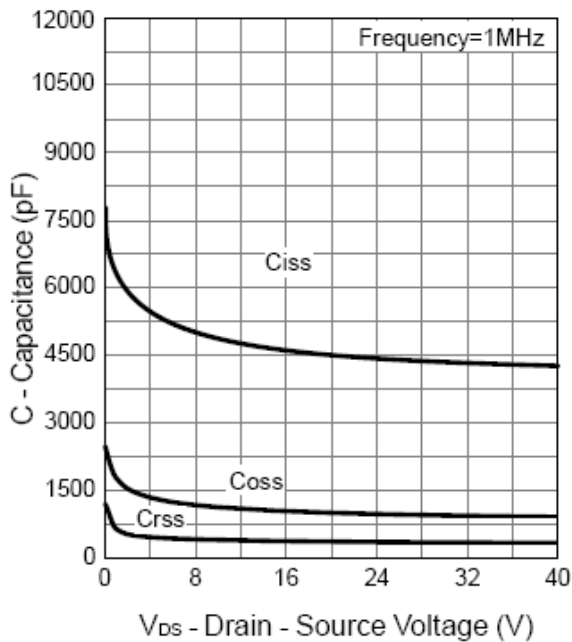

**Gate Charge**

