

## 1. Features

- n  $R_{DS(on)}=10m\Omega$ (typ) @  $V_{GS}=10V$
- n Super low gate charge
- n Green device available
- n Excellent Cdv/dt effect decline
- n Advanced high cell density trench technology

## 2. Description

The KIA4706A is the high cell density trenched N-ch MOSFETs, which provide excellent RDSON and gate charge for most of the synchronous buck converter applications. The KIA4706A meet the RoHs and Green Product requirement.

## 3. Symbol

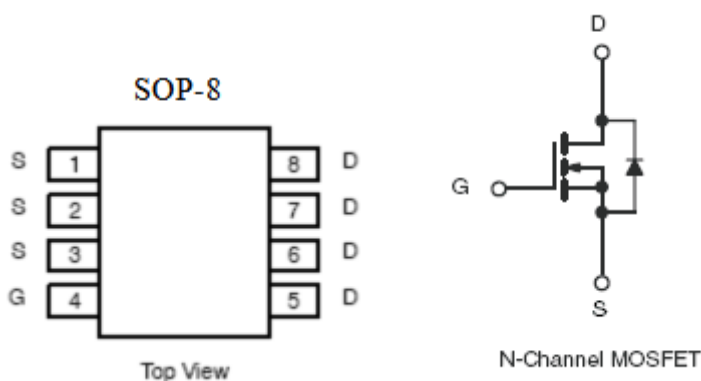

## 4. Absolute maximum ratings

( $T_A=25^{\circ}C$ , unless otherwise noted)

Parameter	Symbol	Rating	Units
Drain-source voltage	$V_{DSS}$	60	V
Gate-source voltage	$V_{GS}$	$\pm 20$	V
Continuous drain current $V_{GS}@10V^1$	$I_D$	$T_A=25^{\circ}C$	8
		$T_A=70^{\circ}C$	6.4
Pulsed drain current <sup>2</sup>	$I_{DM}$	32	A
Single pulse avalanche energy <sup>3</sup>	EAS	72	mJ
Avalanche current	$I_{AS}$	38	A
Total power dissipation <sup>4</sup>	$P_D$	1.5	W
Junction and storage temperature range	$T_J, T_{STG}$	-55 to 150	$^{\circ}C$
Thermal resistance-junction to ambient <sup>1</sup>	$R_{\theta JA}$	85	$^{\circ}C/W$
Thermal resistance-junction to case <sup>1</sup>	$R_{\theta JC}$	24	$^{\circ}C/W$

## 5. Electrical characteristics

( $T_J=25^{\circ}\text{C}$ , unless otherwise noted)

Parameter	Symbol	Test Conditions	Min	Typ	Max	Units
Drain-Source breakdown voltage	$BV_{DSS}$	$V_{GS}=0V, I_D=-250\mu A$	60	-	-	V
$BV_{DSS}$ Temperature coefficient	$\frac{\Delta BV_{DSS}}{\Delta T_J}$	Reference to $25^{\circ}\text{C}$ , $I_D=1\text{mA}$	-	0.052	-	$V/^{\circ}\text{C}$ ,
Drain-Source Leakage Current	$I_{DSS}$	$V_{DS}=48V, V_{GS}=0V,$ $T_J=25^{\circ}\text{C}$	-	-	1	$\mu A$
		$V_{DS}=48V, V_{GS}=0V,$ $T_J=55^{\circ}\text{C}$	-	-	5	
Gate-source leakage current	$I_{GSS}$	$V_{GS}=\pm 20V, V_{DS}=0V$	-	-	$\pm 100$	nA
Gate threshold voltage	$V_{GS(th)}$	$V_{DS}=V_{GS}, I_D=250\mu A$	1.2	-	2.5	V
$V_{GS(th)}$ Temperature coefficient	$\Delta V_{GS(th)}$		-	5.76	-	$\text{mV}/^{\circ}\text{C}$
Static drain-source on- resistance <sup>2</sup>	$R_{DS(on)}$	$V_{GS}=10V, I_D=8A$	-	10	12	m $\Omega$
		$V_{GS}=4.5V, I_D=6A$	-	13	15	
Forward transconductance	$g_{FS}$	$V_{DS}=5V, I_D=8A$	-	45	-	S
Diode forward voltage <sup>2</sup>	$V_{SD}$	$V_{GS}=0V, I_S=-1A,$ $T_J=25^{\circ}\text{C}$	-	-	1.2	V
Gate resistance	$R_g$	$V_{DS}=0V,$ $V_{GS}=0V, f=1\text{MHz}$	-	1.5	-	$\Omega$
Total gate charge(4.5V)	$Q_g$	$V_{DS}=48V, V_{GS}=4.5V$ $I_D=8A$	-	30	-	nC
Gate-source charge	$Q_{gs}$		-	10.7	-	
Gate-drain charge	$Q_{gd}$		-	9.4	-	
Turn-on delay time	$t_{d(on)}$	$V_{DD}=30V,$ $R_G=3.3\Omega, V_{GS}=10V$ $I_D=8A$	-	10.6	-	ns
Rise time	$t_r$		-	9	-	
Turn-off delay time	$t_{d(off)}$		-	65.6	-	
Fall time	$t_f$		-	4.8	-	
Input capacitance	$C_{iss}$	$V_{GS}=0V, V_{DS}=15V$ $F=1.0\text{MHz}$	-	3240	-	pF
Output capacitance	$C_{oss}$		-	210	-	
Reverse transfer capacitance	$C_{rss}$		-	146	-	
Diode characteristics						
Continuous source current <sup>1,5</sup>	$I_S$	$V_G=V_D=0V, \text{Force current}$	-	-	8	A
Pulsed source current <sup>2,5</sup>	$I_{SM}$		-	-	32	A
Reverse recovery time	$t_{rr}$	$I_F=8A, di/dt=100A/\mu s,$ $T_J=25^{\circ}\text{C}$	-	18	-	nS
Reverse recovery charge	$Q_{rr}$		-	15.6	-	nC

Note:1. The data tested by surface mounted on a 1 inch<sup>2</sup> FR-4 board with 20Z copper.

2. The data tested by pulsed, pulse width  $\leq 300\mu s$ , duty cycle  $\leq 2\%$ .

3. The EAS data shows Max.rating. The test condition is  $V_{DD}=25V, V_{GS}=10V, L=0.1\text{mH}, I_{AS}=38A$ .

4. The power dissipation is limited by  $150^{\circ}\text{C}$  junction temperature.

5. The data is theoretically the same as  $I_D$  and  $I_{DM}$ , in real applications, should be limited by total power dissipation.

**6. Test circuits and waveforms**

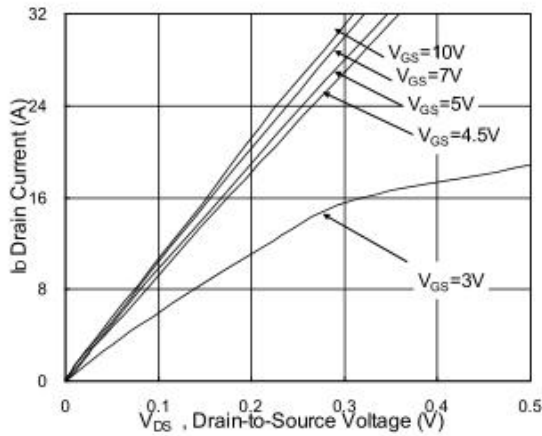

**Fig.1 Typical Output Characteristics**

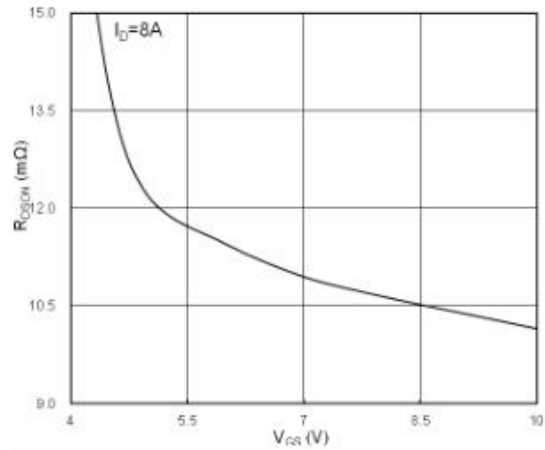

**Fig.2 On-Resistance v.s Gate-Source**

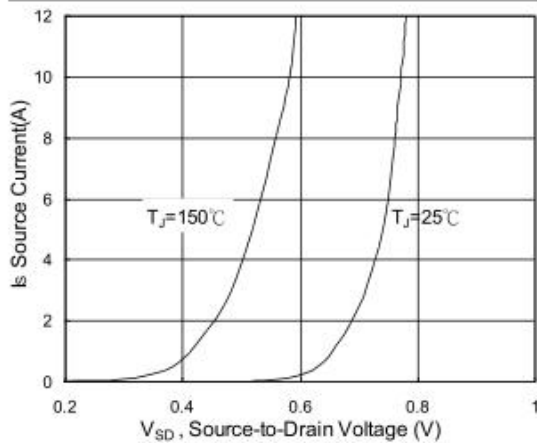

**Fig.3 Forward Characteristics of Reverse**

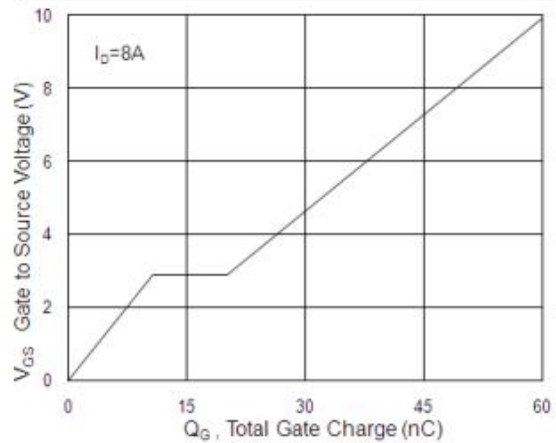

**Fig.4 Gate-Charge Characteristics**

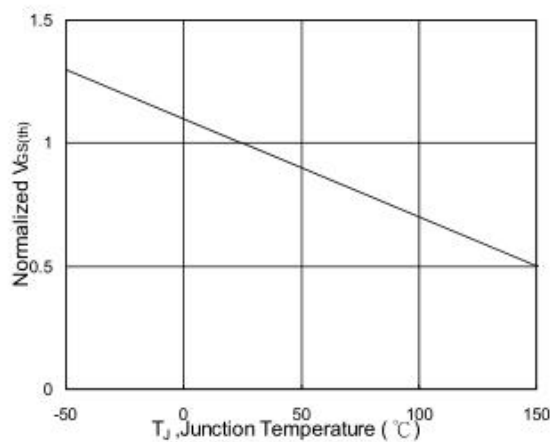

**Fig.5 Normalized  $V_{GS(th)}$  vs.  $T_J$**

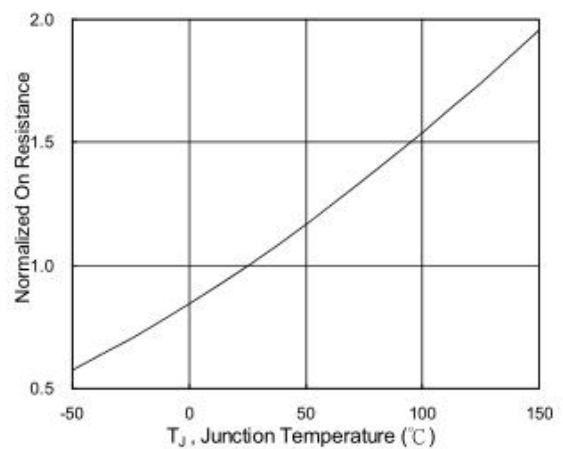

**Fig.6 Normalized  $R_{DS(on)}$  vs.  $T_J$**

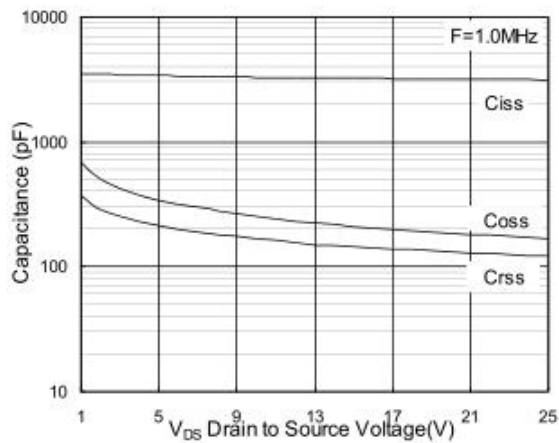

**Fig.7 Capacitance**

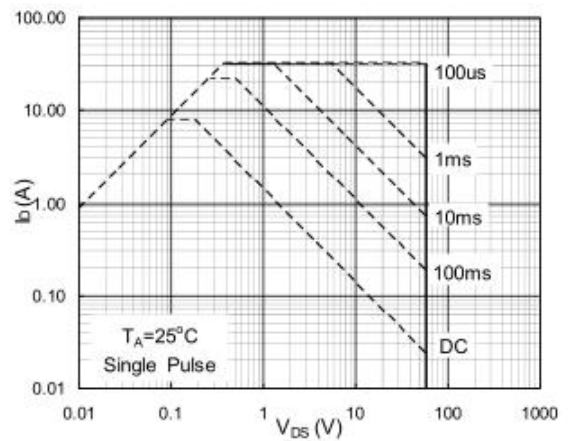

**Fig.8 Safe Operating Area**

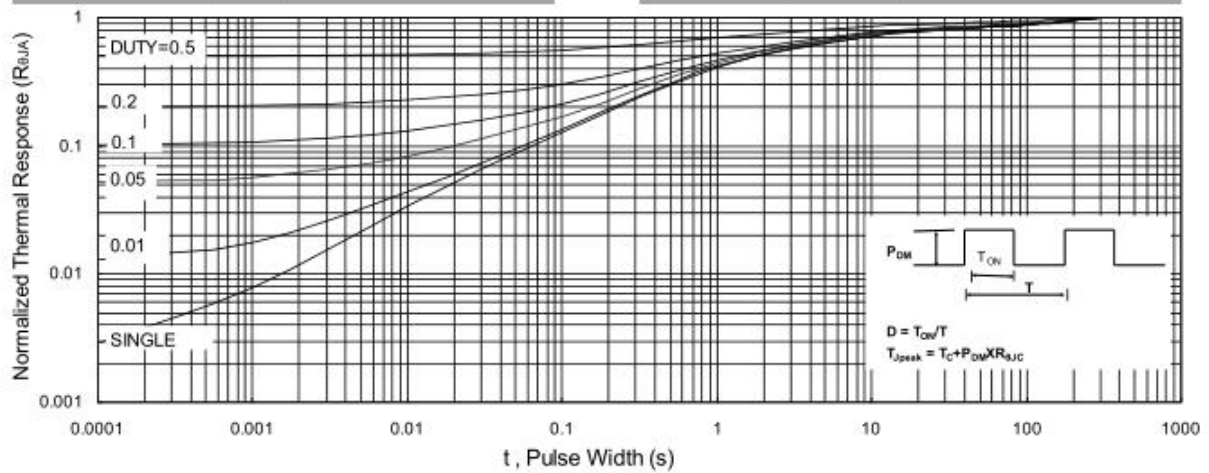

**Fig.9 Normalized Maximum Transient Thermal Impedance**

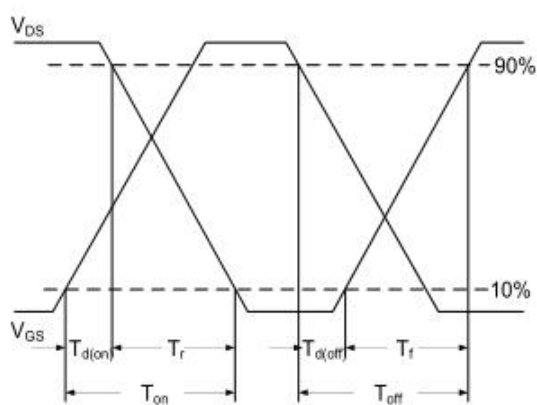

**Fig.10 Switching Time Waveform**

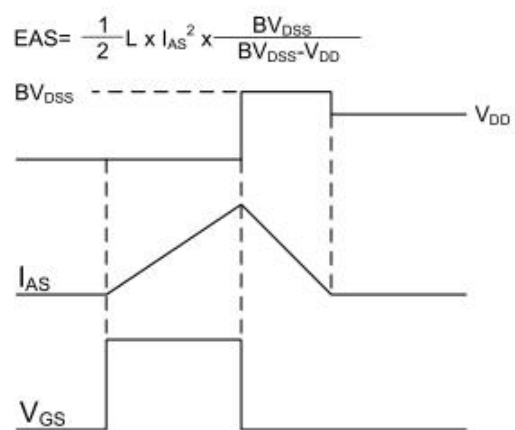

**Fig.11 Unclamped Inductive Switching Waveform**